

MBV2147-P, MBV2155-P

CEILING MOUNT FOR 2 SCREEN, PORTRAIT
MENU BOARD DO 2 EKRAŃÓW, PION

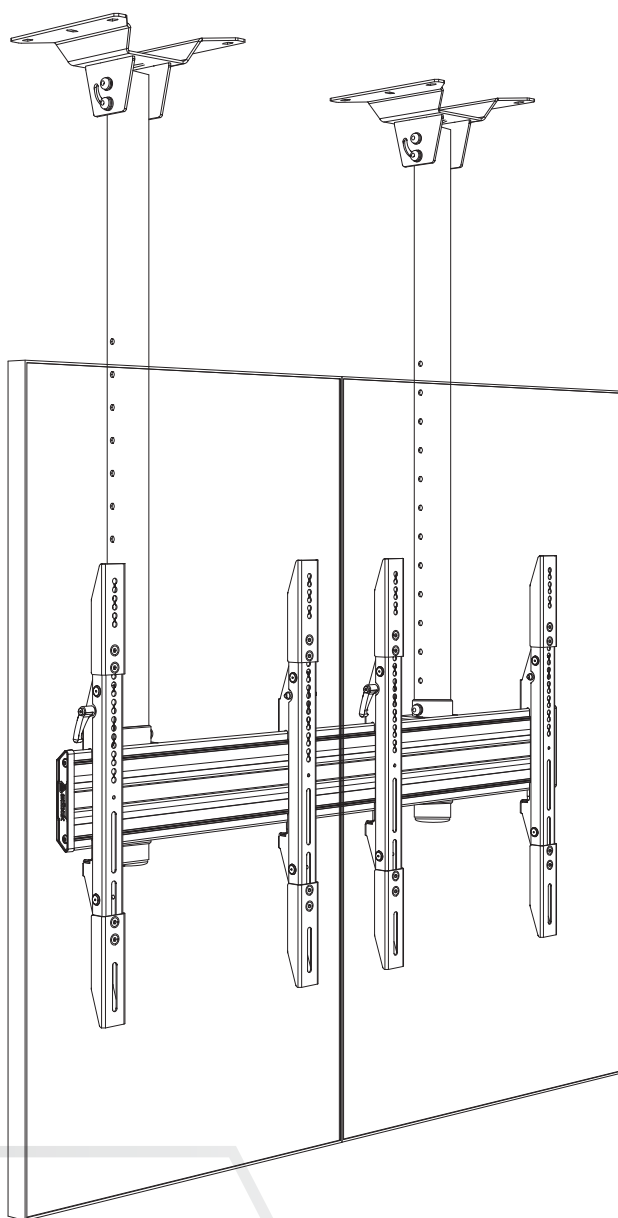

⚠ Warning

Please read this manual before starting the installation to ensure correct assembly.

The assembly should be carried out in accordance with this manual by at least two fully qualified people. The EDBAK Company shall not be liable for any injuries or damage to material or property caused by incorrect assembly. Hence please ensure that:

- during the assembly all the instructions are followed carefully. Failure to do so may result in damage to the product or property, or even personal injury;
- before assembly you must ensure that there are no power cables, or water, sewage or gas pipes in the area of the ceiling where the mount is to be fixed;
- when attaching the projector to the mount, please ensure that the screws are of the correct length and diameter. In order to ensure the correct fit, use the plastic spacers supplied. Use of the wrong screws may result in permanent product damage. Extra caution should be taken with movable parts in order to avoid crushing or pinching your hands or fingers. The movable parts are identified in this manual.

The terms of the product guarantee are detailed in the guarantee card.

⚠ Ostrzeżenie



Przed rozpoczęciem montażu należy uważnie zapoznać się z instrukcją uchwytu oraz ekranu w celu zapewnienia prawidłowego montażu.

Prace montażowe powinny wykonywać co najmniej dwie osoby posiadające kwalifikacje w zakresie montażu zgodnie z niniejszą instrukcją. Firma EDBAK nie bierze odpowiedzialności za straty materialne oraz uszkodzenia mienia lub ciała, wynikające z nieprawidłowego montażu. Dlatego należy zawsze przestrzegać:



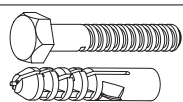
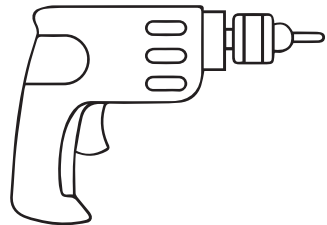

- w trakcie montażu dokładnie przestrzegać załączonej do produktu instrukcji montażowej, w przeciwnym razie może to prowadzić do zniszczenia sprzętu, a nawet uszkodzeń ciała,
- koniecznie przed montażem upewnić się, że pod powierzchnią ściany, na której będzie mocowany uchwyt nie ma kabli elektrycznych, rur wodnokanalizacyjnych lub instalacji gazowych,
- w trakcie montażu ekranu do uchwytu upewnić się, że użyte śruby są dobrze dobrane co do długości i średnicy. W celu idealnego dobrania długości śrub można skorzystać z dołączonych podkładek plastikowych. Zastosowanie niewłaściwych śrub grozi trwałym uszkodzeniem sprzętu,
- w miejscach wskazanych w instrukcji, w których są ruchome elementy uchwytu zachować szczególną ostrożność w celu uniknięcia przyciśnięcia, dłoni i palców.

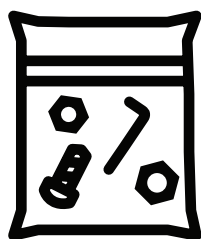

Warunki gwarancji wg załączonej do produktu karty gwarancyjnej.

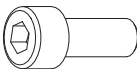

	AA	12x
	FF	1x
	GG	1x



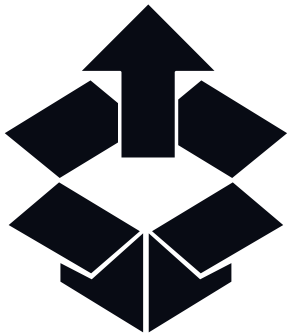

	M4x20	A01	8x
	M5x20	A02	8x
	M6x20	A03	8x
	M8x20	A04	8x
	f15 x f18,4 x 5	A05	8x
	f15 x f18,4 x 10	A06	8x

	M8	A07	8x
	M5	A08	8x
	3mm	A09	1x
	4mm	A10	1x
	5mm	A11	1x
	6mm	A12	1x

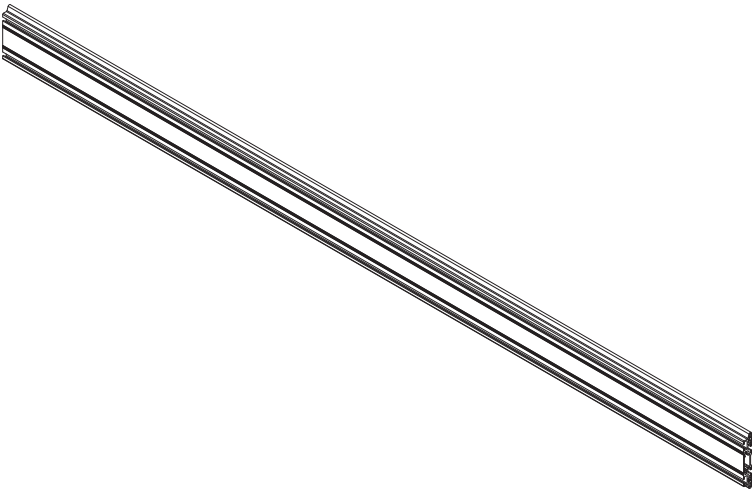
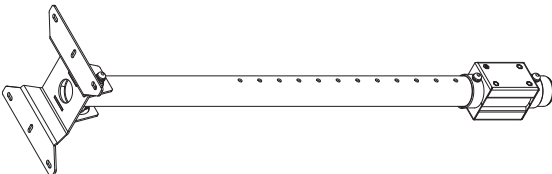

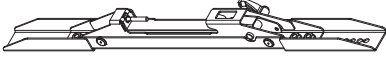
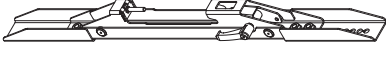
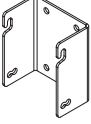
	A	1x
	B	1x

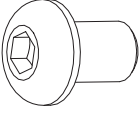
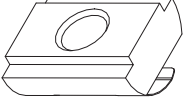
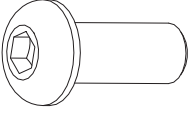
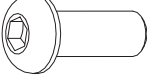
		C	2x
		D	2x
		E	2x
		F	2x
	M8x12	BB	8x
	M8	CC	8x
	Mbx20	DD	8x
	M6x16	EE	8x

1

2x

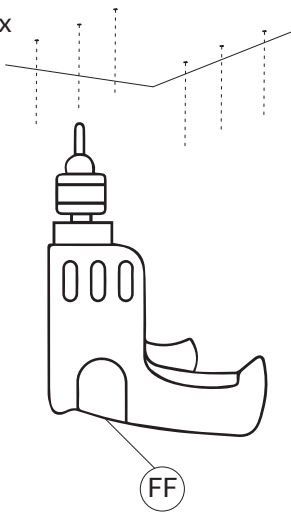

2

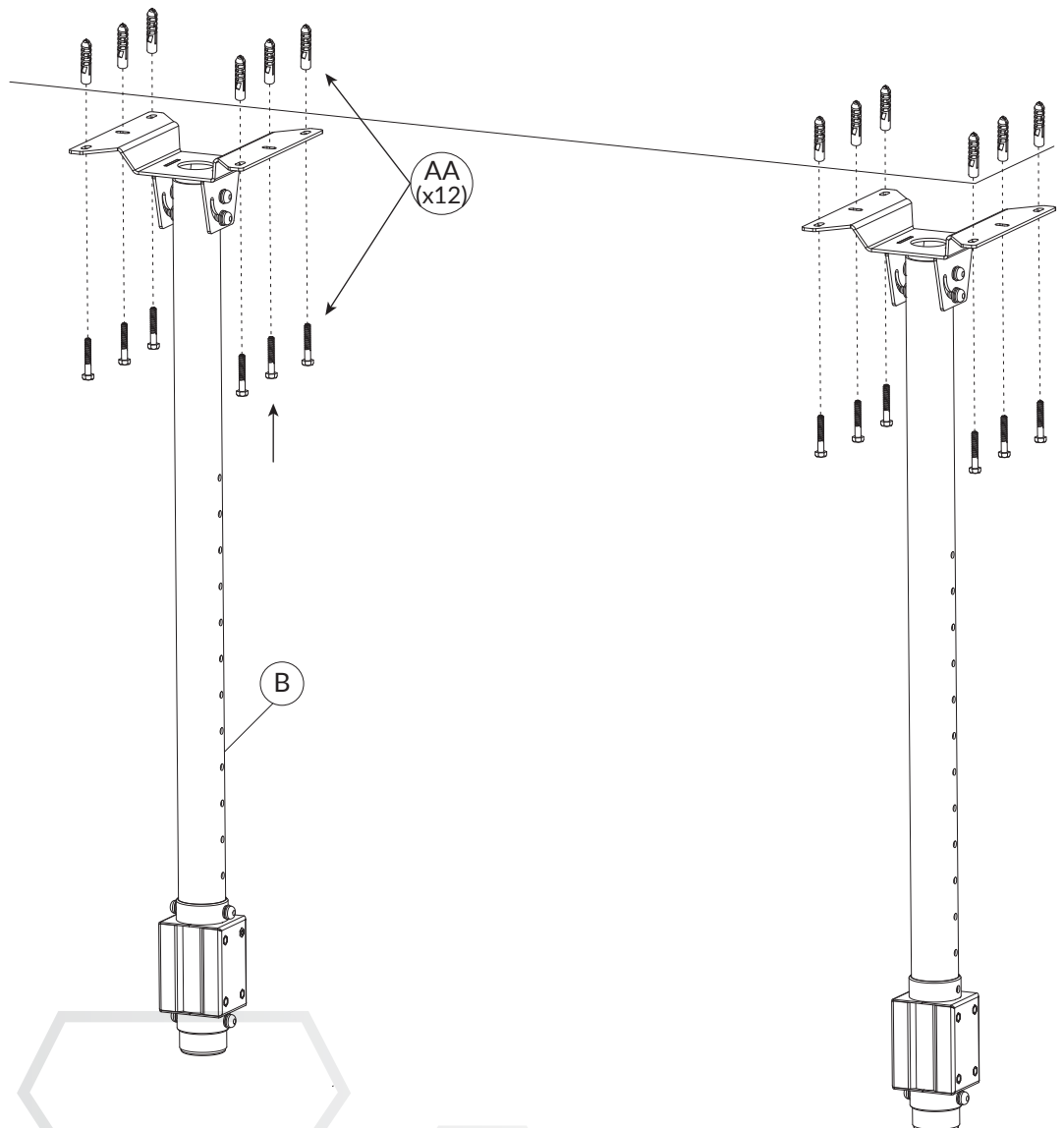

3

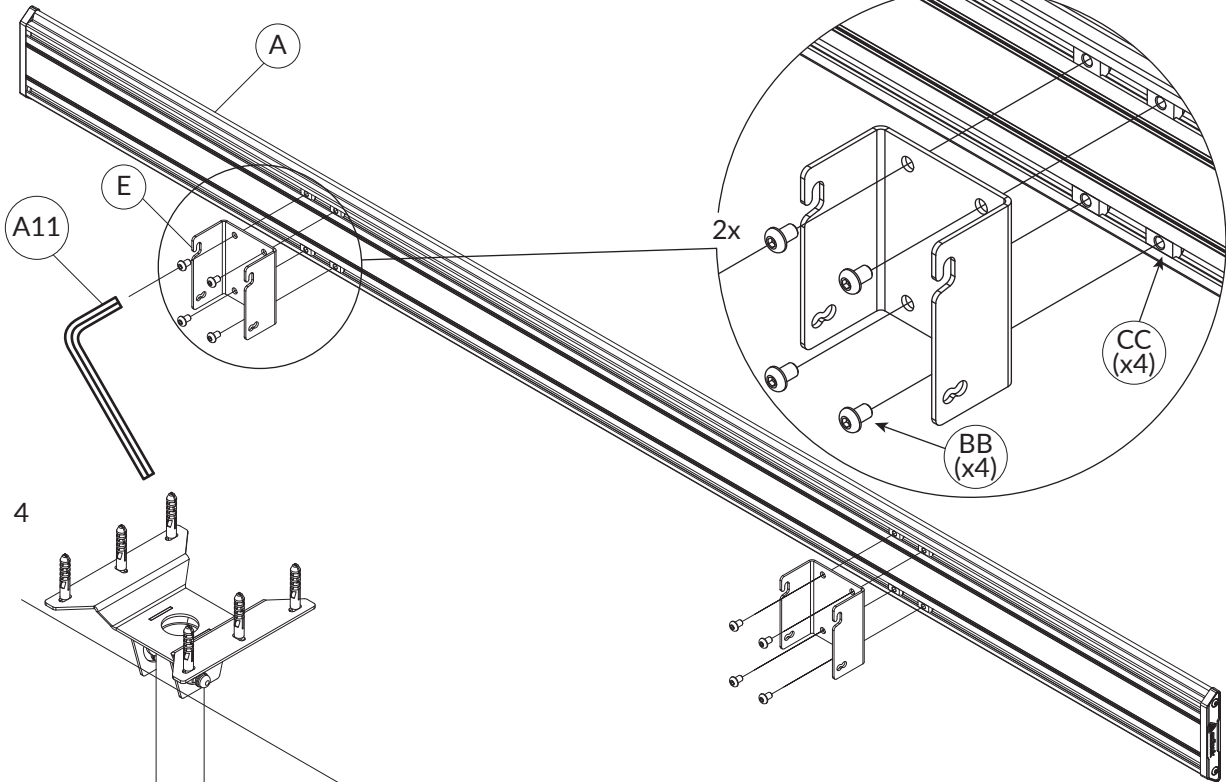

4

